

HOOK CLAMP

HC02

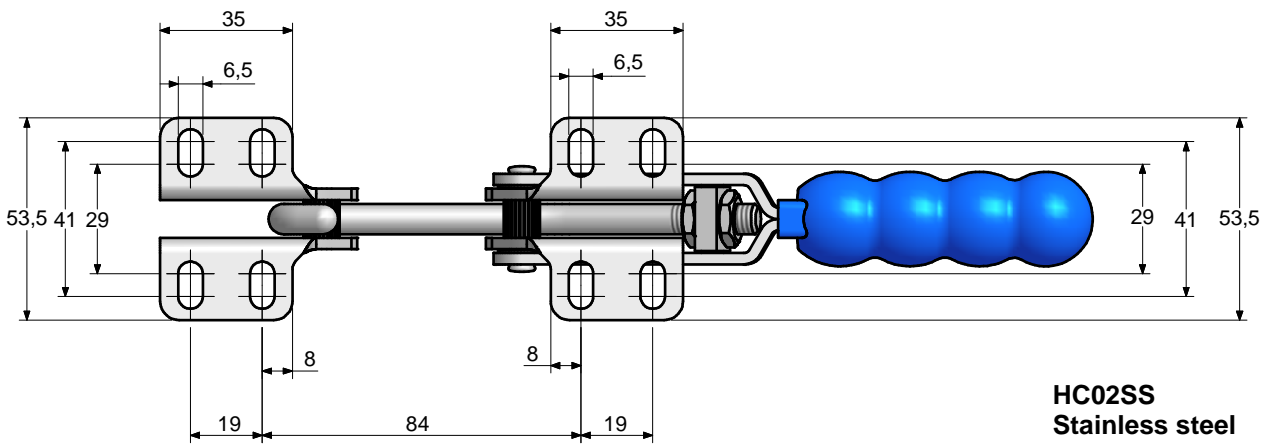

Material: Heavy gauge steel
Finish: Zinc Plated
Supplied with: Hook, Latch plate
Max holding force: 395daN
Weight: 0.3Kgs
Clamping pressure:

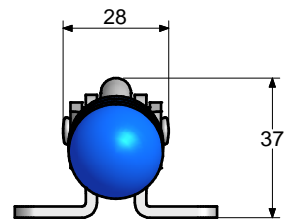
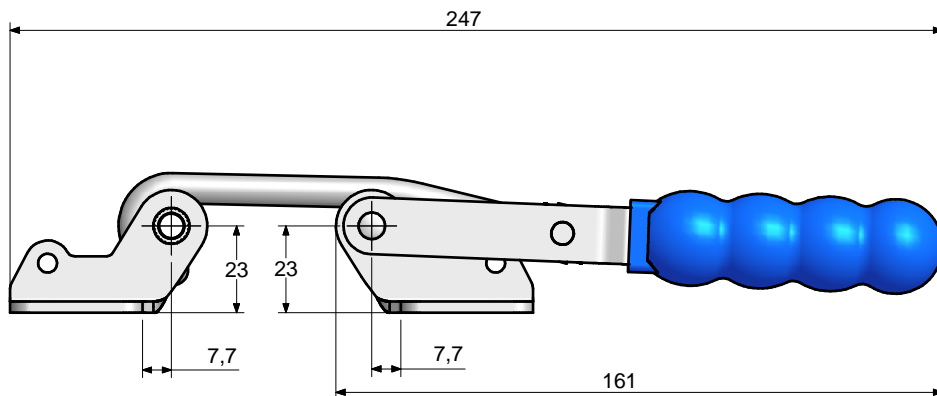
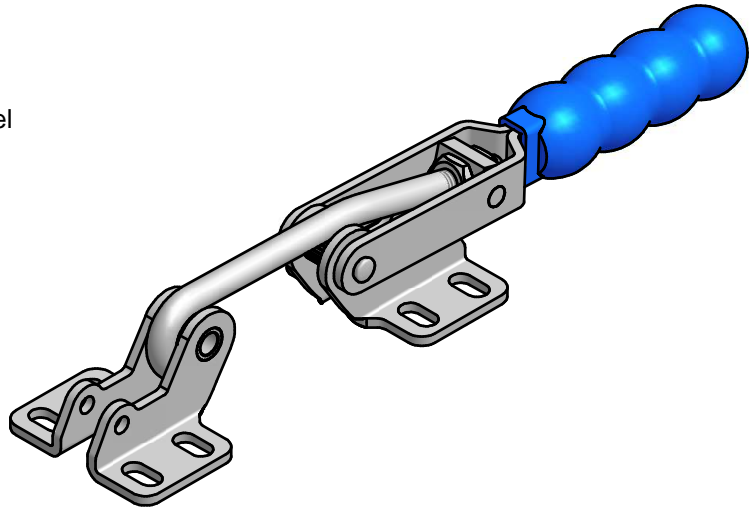
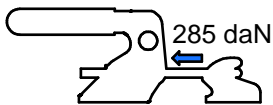

HC02SS
Stainless steel
option available