

PLUNGER ACTION

CP85

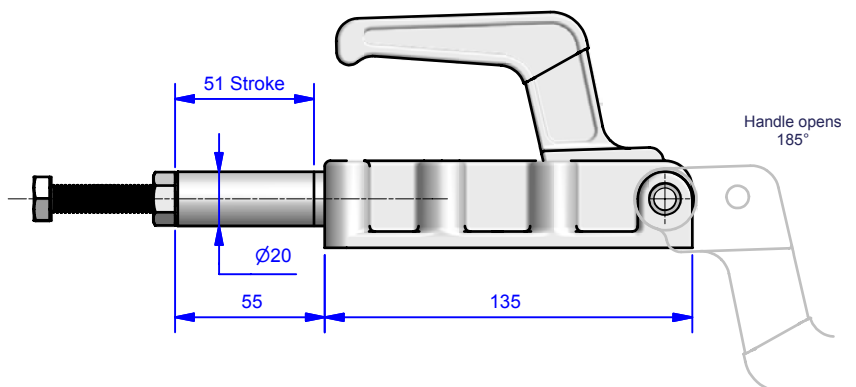

Material: Heavy gauge steel
Hardened pins and bushes
Finishing Chemi blacked
Supplied with: 10x75mm spindle
Max Holding pressure: 1200daN
Weight: 1.5kg - CP85
1.6kg - CP85/90

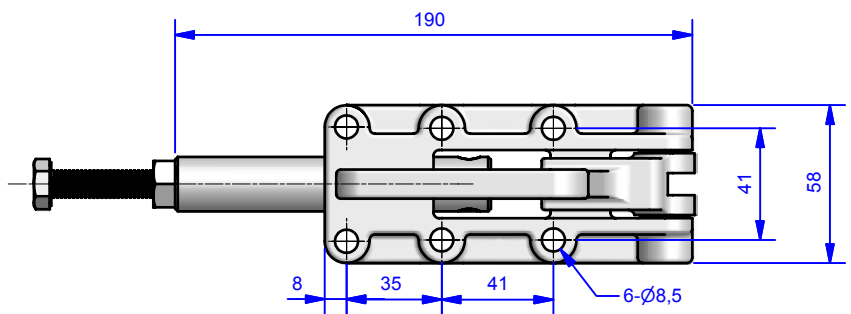
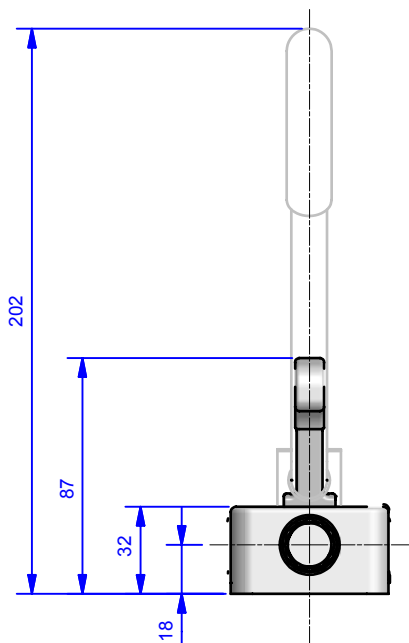
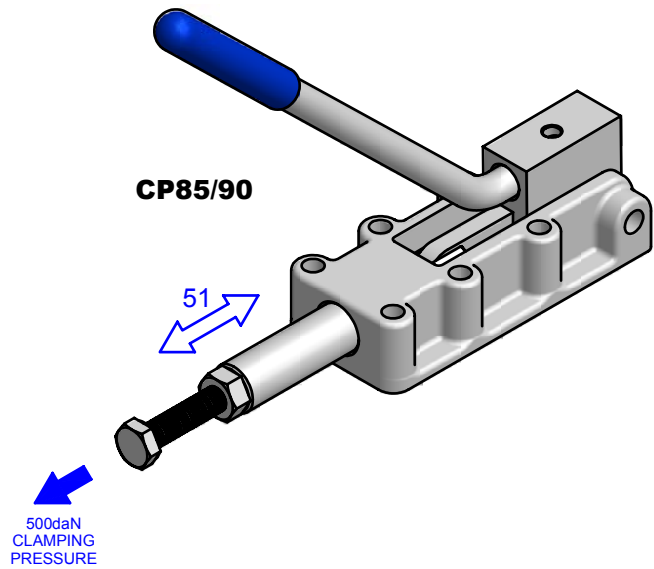
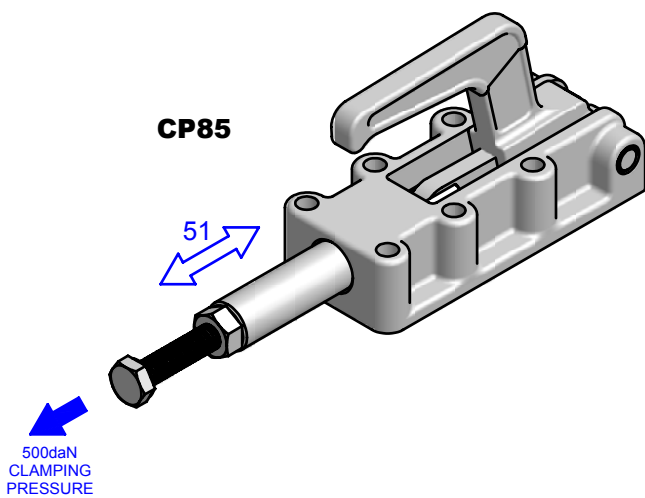

Refer to accessory pages for further information